

KIIRLIIDE - MEHAANILINE LUKUSTUS (NTP)

NIMETUS	MASINAKLASS	KAAL / kg	PUKS Ø		
NTP 10M	15-18t.	176 (kiiluga)	120*70		
NTP 15M	20-22t.	220 (kiiluga)	150*70		



KIIRLIIDE - MEHAANILINE LUKUSTUS (ENGON / S-TÜÜP)

NIMETUS	MASINAKLASS	KAAL / kg	PUKS Ø		
EN 30M/V2	1,5-3t.	26	60*30		
EN 40M	1,8-5t.	53	82*50		
EN 45M	8,5-10t.	110	90*30		



KIIRLIIDE - HÜDRAULILINE LUKUSTUS (NTP)

NIMETUS	MASINAKLASS	KAAL / kg	Silindrite arv	PUKS Ø		
NTP 10H	15-18t.	182	1tk.	120*70		
NTP 15H	20-22t.	220	1tk.	150*70		



KIIRLIIDE

NIMETUS	MASINAKLASS	KAAL / kg	Silindrite arv	PUKS Ø		
S50M +3t. konks	8,5 - 10t.	113		90*50		
S50H +3t. konks	8,5 - 10t.	118	1tk.	90*50		
S50H	8,5 - 10t.	115	1tk.	90*50		

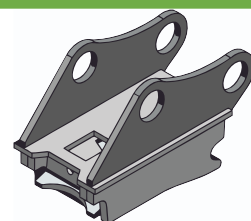

KIIRLIIDE - HÜDRAULILINE LUKUSTUS (ENGON / S-TÜÜP)

NIMETUS	MASINAKLASS	KAAL / kg	Silindrite arv	PUKS Ø		
EN 40H	1,8-5t.	58	1tk.	82*45		
EN 45H	8,5-10t.	115	1tk.	90*50		
S 60H	13,5-15t.	180	1tk.	120*70		
S 70H	18-22t.	240	1tk.	150*70		



KIIRLIIDE - POOLAUTOMAATNE LUKUSTUS (ENGON / S-TÜÜPI)

NIMETUS	MASINAKLASS	KAAL / kg		PUKS Ø		
S40PA	1,8-5t.	50		82*50		



PUKSID (1 komplekt = 4 puksi)

NIMETUS	PUKS Ø	KAAL / kg		
Puks EN30...EN45	Ø60 - 90 *50	10		
Puks NTP10/S60	Ø120*70	17		
Puks NTP15/S70	Ø150*70	28		
Puksid	Pukside komplekti paigaldus/keevitus			

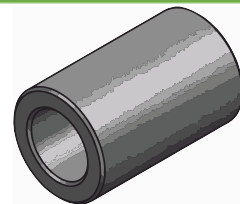

LISAVARUSTUS - Tõstekonks kiirliidetele (koos keevitusega)

NIMETUS	A mm	W mm	P mm	T mm	L mm	H mm	F mm	Kaal kg		
2T	5	5	5	5	5	5	5	5		
3T	6	6	6	6	6	6	6	6		
5T	10	10	10	10	10	10	10	10		

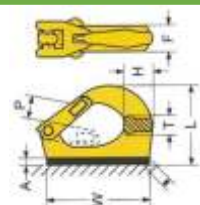

KALLUTAV KIIRLIIDE EN (mehaaniline ja hüdrauliline lukustus)

NIMETUS	MASINAKLASS	KAAL / kg	Silindrite arv
EN 30MK/V1	1,5-3t.	48	1tk.
EN 30MK/V2	1,5-3t.	54	1tk.
EN 40MK	1,8-5t.	93	1tk.
EN 40HK	1,8-5t.	93	1tk.
EN 40PAK	1,8-5t.	155	1tk.
EN 45MK	8,5-10t.	158	1tk.
EN 45HK	8,5-10t.	160	1tk.
EN 45HK 2-silinrit	8,5-10t.	181	2tk.
EN 45MK 2-silinrit	8,5-10t.	178	2tk.
PUKSID	Pukside komplekt Ø60...Ø90		
PUKSID	Pukside komplekti paigaldus / keevitus		



KALLUTAV KIIRLIIDE NTP (hüdrauliline lukustus)

NIMETUS	MASINAKLASS	KAAL / kg	Silindrite arv
NTP 10HK 45	15-18t.	410	2tk.
NTP 15HK 45	20-22t.	420	2tk.
NTP 10HK 45 1sil.			1tk.
PUKSID	Pukside komplekt Ø120...Ø70 (NTP 10HK)		
PUKSID	Pukside komplekt Ø150(NTP15H/M/HK)		
PUKSID	Pukside komplekti paigaldus / keevitus		



KALLUTAV KIIRLIIDE S-SEERIA (hüdrauliline lukustus)

NIMETUS	MASINAKLASS	KAAL / kg	Silindrite arv
S 60 HK 45	13,5-15t.	440	2tk.
S 70 HK 45	18-22t.	502	2tk.
PUKSID	Pukside komplekt Ø120...Ø70 (S60)		
PUKSID	Pukside komplekt Ø150...Ø70 (S70)		
	Pukside komplekti paigaldus / keevitus		



NIMETUS	Tsentrite vahe A(mm)	Sisemiste põskede vahe B(mm)	Ava Ø C(mm)
EN 30 / V1	130	150	Ø60
EN 30 / V2	130	150	Ø60
EN 40	230	165	Ø82
EN 45	310	225	Ø90
EN 60	400	325	Ø120
NTP 10	400	325	Ø120
NTP 20	470	350	Ø150

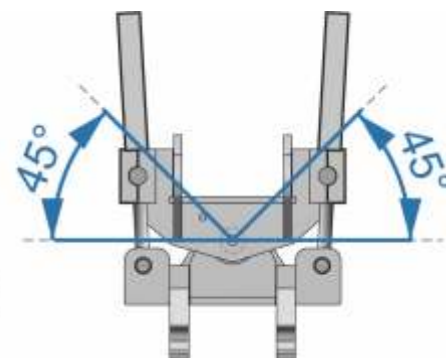
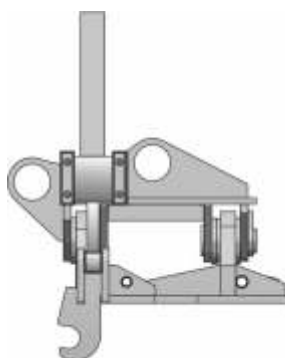
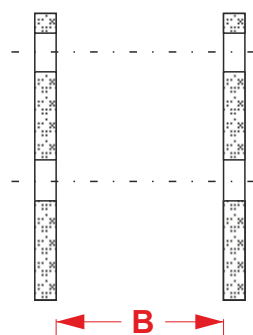
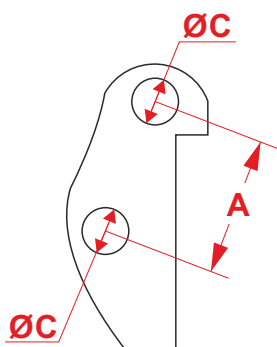

KIIRLIITED JA KINNITUSTE TÜÜBID / PEALISPLAAT NTP

NIMETUS	A (mm)	B (mm)	C (mm)	D (mm)	E (mm)	MASINAKLASS	KAAL / kg
NTP 10	405	235	70	118	755	13-22t.	115
NTP 20	485	345	80	115	800	22-32t.	160
NTP 30	525	340	80	115	800	26-32t.	220

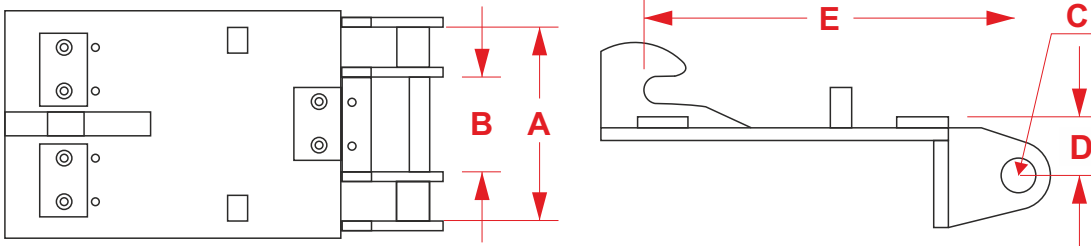

KOPA PEALSED KINNITUSED ENGON JA S-TÜÜP (KÕRVAD - VÖLLID)

NIMETUS	A (mm)	B (mm)	C (mm)	KAAL / kg	MASINAKLASS
S 30 / V1	30	150	200	7	1,5-2t.
S 30 / V2	30	180	230	8	1,5-2t.
S 40	40	200	300	14	1,8-5t.
S 45	45	290	430	23	8,5-10t.
S 50	50	270	430	27	8,5-10t.
S 60	60	340	480	44	12-15t.
S 70	70	450	600	71	20-22t.
S 80	80	590	670	145	25-30t.



KOPA PEALSED KINNITUSED GJERSTAD JA CAT-TÜÜP (KÕRVAD - VÖLLID)

NIMETUS	A (mm)	B (mm)	C (mm)	KAAL / kg	MASINAKLASS
GJ - 300	95*17,5	303		46	13,5 - 15t.
GJ - 500	133*17,5	508		93	18 - 22t.
CAT Caterpillar	60	550	475	205	18 - 22t.
Miller JCB	Ø60	220	375	45	12 - 15t.
Miller JCB	Ø65	255	400	50	18 - 22t.
Miller JCB	Ø80	310	450	135	25 - 30t.

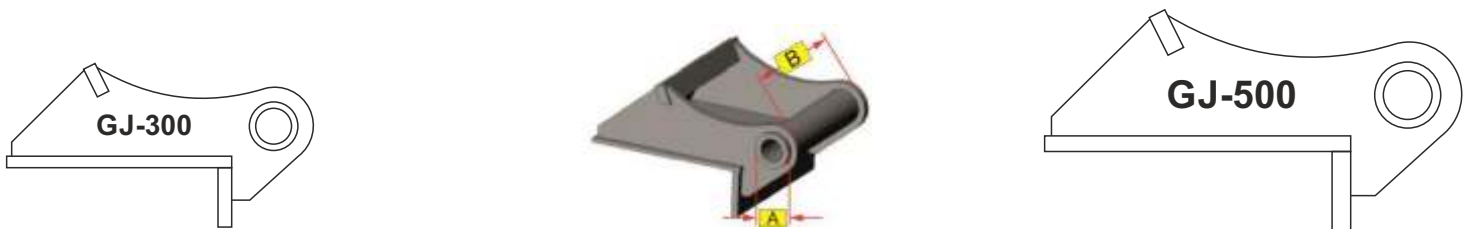

ADAPTERID

NIMETUS	KAAL / kg	MASINAKLASS
NTP10 / NTP20M	302	15 - 25t.
NTP20 / NTP10M	309	15 - 25t.
MILLER Ø65 / NTP10M	189	14 - 22t.
JCB Ø80 / NTP10M	189	14 - 22t.
S60 / NTP10M	189	14 - 22t.



TAGAVARAOSAD

NIMETUS	VARUOSA	KOGUS	MÕÕDUD		
NTP10HK / NTP15HK	Hüdr. lukustus kiil (kaal 5,3kg)	1tk.			
Kopa laepealsete pukside komplekt	Ø160*Ø85*59 / Ø160*Ø70*59		Kompl.=2tk.		
Karastatud teraspukside komplekt	Ø105*Ø85*85		Kompl.=2tk.		
Keskvõll kallutatavatele planeer kopale	Ø85*710 +stopri ja poldiga KP1,55...KP1,9 Keskvõll		Kompl.=1tk.		
Kiil (mehaaniline)	NTP10M / NTP15M / NTP20M	1tk.			
Kiil (hüdrauliline)	NTP10H / NTP15H	1tk.			
Silinder (KP1,45...KP1,9V)	Rangidega silinder	1tk.	Ø100x60x500		
Silinder (NTP10HK / NTP15 HK / S60HK)	Rangidega silinder	1tk.	Ø80x50x480		
Silinder (NTP10HK / NTP15 HK / S60HK)	Rangidega silinder	1tk.	Ø80x50x300		
Silinder (EN40MK / EN40HK / EN45MK / EN45HK)	Rangidega silinder	1tk.	Ø63x40x295		
Silinder (KP1,7L / KP1,95L)			Ø100x60x200		
Silinder (KP1,5L)			Ø80x40x180		
S40H Lukustusilinder	Koos plokiga				
Reguleerimisplaat (NTP10 / NTP15)	reg. pakk		#12 mm		
Reguleerimispeil (NTP10 / NTP15)			#2 - 4mm		
Hüdraulilise lukustuse silinder(Ø70x32x80) Verdusilinder	NTP10H / NTP10HK / NTP15H / NTP15HK				



CAT tüüpi kihvad ja adapterid caeve koppadele

NIMETUS	SEADE	MÕÕT	KAAL kg	INFO		
CAT - V TÜÜP	Kihv	# 20	1,3	Koos stopperpoldi / lukustiga		
CAT - ADAPTER	Adapter	# 20	1,6			
CAT - V TÜÜP	Kihv	# 25	3,1	Koos stopperpoldi / lukustiga		
CAT - ADAPTER	Adapter	# 25	4,5			
CAT - V TÜÜP	Kihv	# 30	4,3	Koos stopperpoldi / lukustiga		
CAT - RC TÜÜP	Kihv	# 30	6,0	Koos stopperpoldi / lukustiga		
CAT - ADAPTER	Adapter	# 30	7,1			
CAT - V TÜÜP	Kihv	# 40	6,0	Koos stopperpoldi / lukustiga		
CAT - RC TÜÜP	Kihv	# 40	8,1	Koos stopperpoldi / lukustiga		
CAT - ADAPTER	Adapter	# 40	10			
CAT - V TÜÜP	Kihv	# 50	11	Koos stopperpoldi / lukustiga		
CAT - RC TÜÜP	Kihv	# 50	15,5	Koos stopperpoldi / lukustiga		
CAT - ADAPTER	Adapter	# 50	21			
ITR - KIHV	Kihv	# 20	5	Poldistatav kihv		

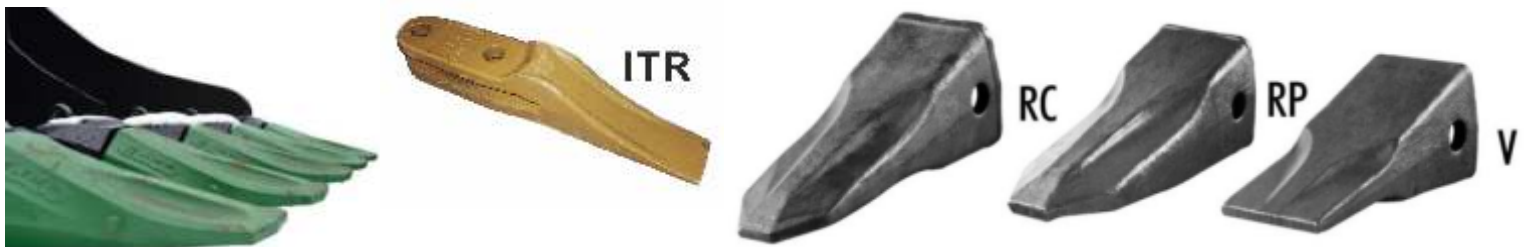

VARUOSAD

NIMETUS	MÕÕT / MATERJAL	TÜÜP	Komplektsus		
Esitera KP1,9	#30*270*1900/Hardox500	KP1,9	1tk.		
Esitera KP1,7	#30*270*1700/Hardox500	KP1,7	1tk.		
Esitera KP1,55	#30*270*1550/Hardox500	KP1,55	1tk.		
Põhja kuluriba KP1,9	#16*100L=8,8jm/Hardox500	KP1,9			
Põhja küljeriba / suusk	#16* 2tk. /Hardox400	KP1,55...KP1,9	Kompl.=2tk.		
Küljetera / uisk	#20* 2tk. /Hardox400	KP1,55...KP1,9	Kompl.=2tk.		
KP kallutusosa toru koos piksidega					
Kummirõngas	Ø160*Ø12	KP1,55...KP1,9	Kompl.=2tk.		
Silindrikronstein koos sõrmega	Koos sõrmega Ø60	KP1,45...KP1,9			
Silindri sõrm	Ø60	KP1,45...KP1,9			
Kallutussilindri rangi fiksaatorkronstein		KP1,45...KP1,9	Kompl.=1tk.		
Kallutussilindri varras	Ø60 + GE 60 silmalaager				
Kallutussilindri remont komplekt	Ø100 remont mansettide komplekt		KP1,45V ... KP1,9V		
Kallutussilindri varras	Ø50 + GE 50 silmalaager		NTP10HK / NTP15HK		
Kallutussilindri remont komplekt	Ø80 remont mansettide komplekt		S 6 0 H K / S 7 0 H K		
KP 1,45V keskvoil	Ø70 + (stopperpolt / stopperrõngas)				
Hüdr.silindri otsamutter mansettidega	Ø 100		1tk.		
Hüdrovoolikute komplekt (2-püstsilindrit)	KP1,55V / KP1,7V / KP1,9V				
Kolb	Ø 100 (rang.sil. Ø 100)				
Volvo BM 120 kronstein	1 kompl. (2tk)		2tk.		
Volvo Zettermeyer					
Monitou kinnitus					
JCB Q-Fit kinnitus					
H. silinder (KE8L / KE7L)	Ø 70x40x150				
Stopperpolt M30x2 (stopperrõngas)	(KP1,55V ... KP1,9V)				
Pl.kopa KM55 kallutusosa silindritega	(Silinder 40x20x110 2tk.) voolikutega		1tk.		
Pl.kopa KM220 kallutusosa silindritega	(Silinder 50x30x150 2tk.) voolikutega		1tk.		
KP 1,45 (plastpuks)	Ø 70		1tk.		
KE7L /KE8L (plastpuks)	Ø 60 x Ø70		1tk.		
NTP10 „Saabas” (kinnituskronstein)	M24 polt + mutter		1 kompl.		
KE7 ja KE8 keskvoil	Ø 60		1tk.		
Laager GE 80					
Laager GE 60					
Laager GE 50					
Kiirliite silindri sõrm	Ø50mm *12				
Kallutava kiirliite sõrm	Ø80 (S60HK/S70HK/NTP10HK/NTP15HK) koos stopri ja lukustiga				

LUKUSTUSKONKS

LUKUSTUSKONKS



NTP10 / NTP15

1tk.

#40 Weldox

NTP20 / NTP30

1tk.

#50 Weldox

HAAKEKONKSUD

NIMETUS	MÕÕT / MATERJAL	TÜÜP	KAAL		
Haakekonks (paar)	#50 / S355	NTP10M / NTP15	61		
Haakekonks (paar)	#60 / 355	NTP10HK / NTP 15HK	84		



KIIRLIIDETE NTP10M/ NTP10H/NTP 10HK NTP15M/ NTP15H/ NTP15HK PUKSIDE PAIGALDUS JOONIS

**LISA PUUDUVAD
MÕÖDUD !**

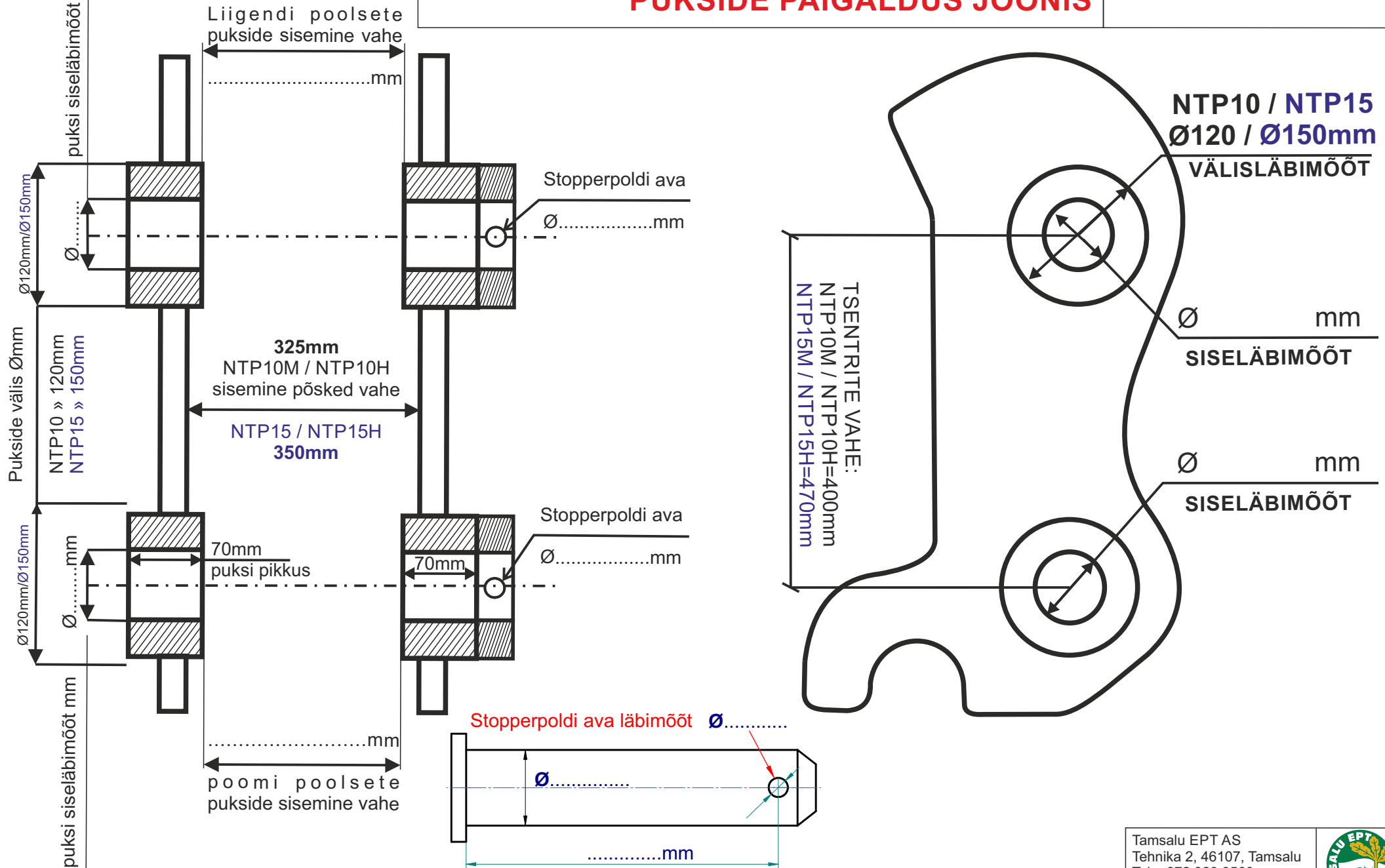

Kaugus poldi/võlli pea tagant kuni stopperpoldi tsentrini.

Tamsalu EPT AS
Tehnika 2, 46107, Tamsalu
Tel. +372 323 0560
Fax. +372 324 5972



